

User's Guide



Control System

USA
SERVICE OFFICE
Dometic Corporation
2320 Industrial Parkway
Elkhart, IN 46516
574-294-2511

CANADA
Dometic Corporation
46 Zatonski, Unit 3
Brantford, ON N3T 5L8
CANADA
519-720-9578

**For Service Center
Assistance Call:**
800-544-4881

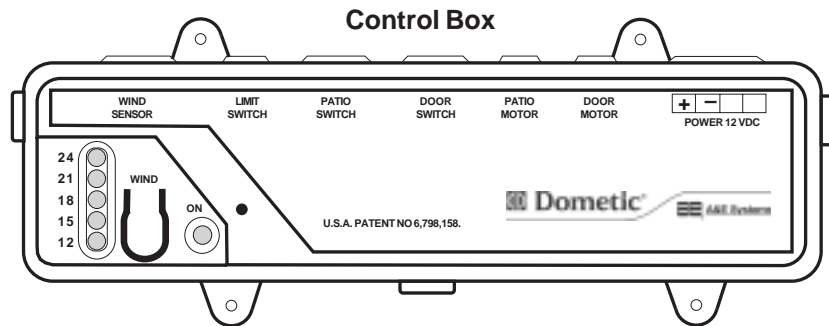

Remote Control (Key FOB)

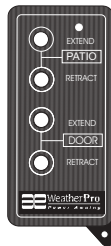

Remote Rocker Switch

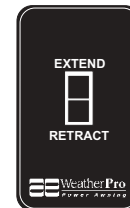

User's Guide

**WeatherPro Power
Awning
&
Oasis Door Awning**

SAFETY INSTRUCTIONS

This manual has safety information and instructions to help users eliminate or reduce the risk of accidents and injuries.

RECOGNIZE SAFETY INFORMATION



This is the safety-alert symbol. When you see this symbol in this manual, be alert to the potential for personal injury.

Follow recommended precautions and safe operating instructions.

UNDERSTAND SIGNAL WORDS

A signal word, **WARNING OR CAUTION** is used with the safety-alert symbol. They give the level of risk for potential injury.

WARNING indicates potentially hazardous situation which, if not avoided, could result in death or serious injury.

CAUTION indicates a potentially hazardous situation which, if not avoided, may result in minor or moderate injury.

CAUTION used without the safety alert symbol indicates, a potentially hazardous situation which, if not avoided, may result in property damage.

Read and follow all safety information and instructions.

OPERATING INSTRUCTIONS

To Open Awning:

1. Using The Remote Control (Key FOB)
 - a. Press and hold the "Extend" button for 3 seconds and the awning will automatically open. If not held for three seconds the awning will remain in the position when button is released and will continue to extend when pressed again.
2. Using The Remote Rocker Switch
 - a. Press and hold the "Extend" button for 3 seconds and the awning will automatically open. If not held for three seconds the awning will remain in the position when button is released and will continue to extend when pressed again.

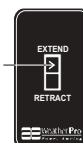

Important: When the power has been interrupted, wait approximately 30 seconds before depressing button again. The control box will automatically restore power when button is pressed again.

Important: When installed correctly on a motorized RV, this system is wired to prevent accidental awning "extension" when vehicle ignition key is in the "ON" position. When the ignition key is turned "ON", the "extension" mode is de-activated and awning will not extend. This however, will not prevent the awning from being retracted.

The A & E WeatherPro awning is equipped with a wind sensing device that will automatically close the awning when wind conditions are present that may damage the awning. The factory preset setting is 18 MPH. To activate the wind sensor feature, locate the control box (usually mounted in a storage compartment), simultaneously depress and hold buttons 1 & 2 on the Remote Control (Key FOB) for 3 seconds. One of the wind speed LED's will illuminate.

To de-activate the wind sensor feature, simultaneously depress and hold buttons 3 & 4 on the Remote Control (Key FOB) for 3 seconds. There are no wind speed LED's illuminated when de-activated. Damage to the awning may occur in high winds if the awning is left in the open position with this feature de-activated. Wind sensor is activated when shipped from the factory.

Important: Do not attach or hang any objects from the awning or tie the awning down. If the sensor is activated or the retract button is depressed and the awning rolls up, damage to the awning and attached objects may occur.

Simultaneously press and hold buttons 1 & 2 for 3 seconds to activate wind sensor

Simultaneously press and hold buttons 3 & 4 for 3 seconds to deactivate wind sensor

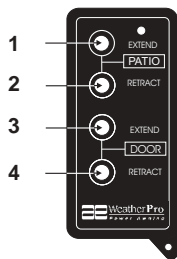

Obstructions in the proximity of the wind sensor can diminish the sensitivity.

If wind sensor is de-activated and damage to awning occurs, the awning warranty may be void.

The wind sensor is specifically designed to allow air to pass across sensor probe.

Important: The wind sensor will only function correctly if the airway to the sensing probe is clear. Keep airway clear of dust, insects, ice, snow, or other debris. The sensing probe can be cleaned with a mild soap solution and a small soft bristle brush.

There are six (6) LED's in the WeatherPro control and one button for selecting the wind speed.

A. 12 VDC Power Indicator

1. Constant Yellow indicates there is 12 VDC power at the control.
2. Flashing Yellow at the rate of 1 time per second, indicates voltage is below 10 ($\pm .50$) VDC. Awning will not operate.
3. Flashing Yellow at the rate of 3 times per second, indicates a fault has been detected in the wind sensor or the wind sensor cable.

B. Wind Speed Setting

1. The LED that is yellow indicates the wind speed currently selected.

C. Wind speed selection button

1. Wind speed is preset from the factory at 18 MPH.
2. The wind speed can be adjusted by pressing the wind speed selection button. To increase or decrease the sensor sensitivity, press and release the wind speed selection button until the desired wind speed LED is lit. The recommended setting is 18 MPH.

Note: Awning is not intended for cold weather operation. Awning will automatically close when outside temperature reaches 32° F. when the wind sensor is activated.

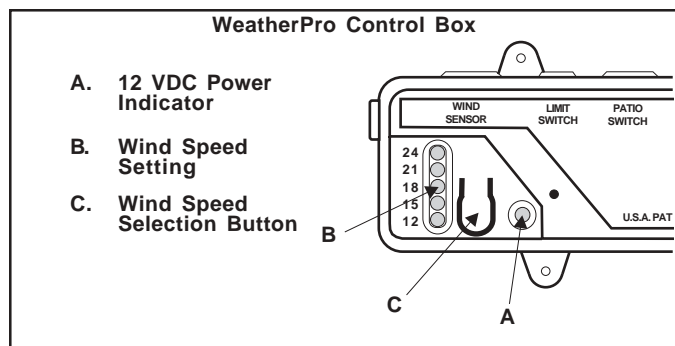

CAUTION

The A&E WeatherPro awning is extremely durable and can be operated during light rain and wind conditions. However, when periods of heavy rain, or wind is expected; or you leave the awning unattended the awning should be closed. Damage caused by wind and rain is not covered by warranty.

D. Left Arm

Your A & E awning is designed to shed water if left out in light rain. If water builds up on the awning, the left arm will automatically decrease the awning height approximately 9 inches. When there is no longer the need to shed water it will return to the normal height.

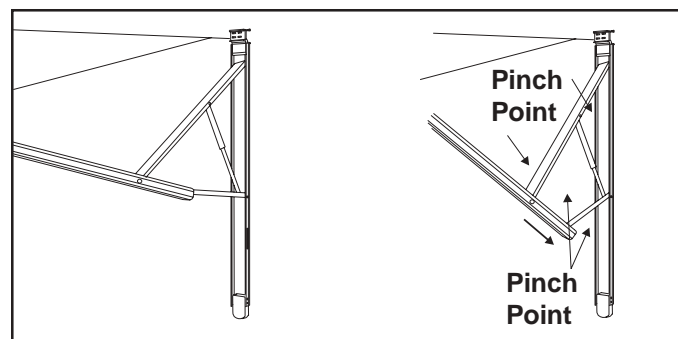

To Close Awning:

1. Using The Remote Control (Key FOB)
 - a. Press and hold the "Retract" button for 3 seconds and the awning will automatically close. If not held for three seconds the awning will remain in the position when button is released and continue to close when pressed again.
2. Using The Remote Rocker Switch
 - a. Press and hold the "Retract" button for 3 seconds and the awning will automatically close. If not held for three seconds the awning will remain in the position when button is released and continue to close when pressed again.

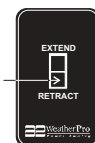
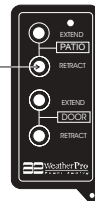

Important: As an extra safety precaution, visually verify that the awning is fully closed.

In Case Of Coach Power Failure

1. When the WeatherPro hardware is in the open position and the 12 VDC power has been lost the awning can be closed by using the auxiliary power cable provided with the hardware. Connect the awning motor to an external 12 VDC power source. A good external 12 VDC power source would be an automobile battery.

2. Locate and unplug the motor and hardware cable connection located in the upper part of the right hand arm.

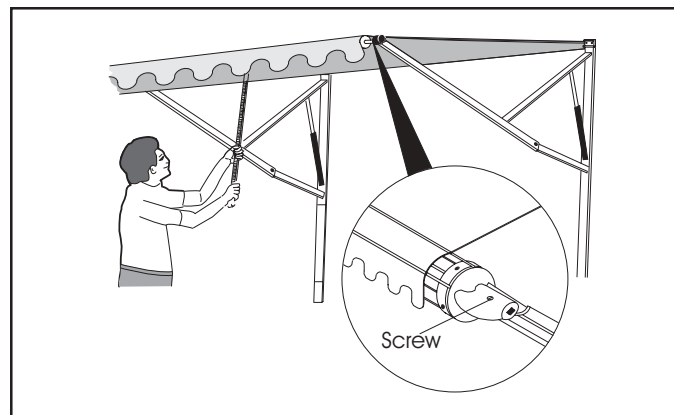
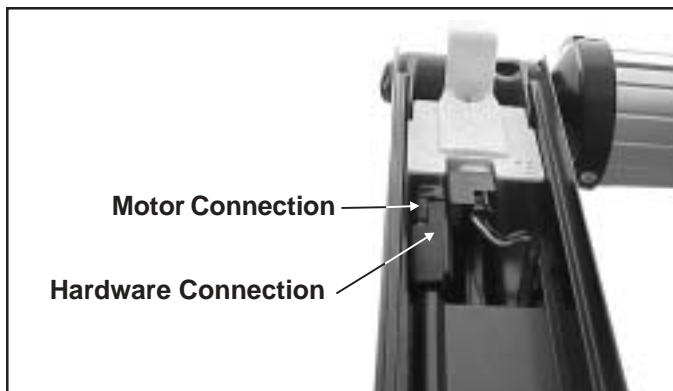

3. Connect the supplied auxiliary power cable to the connector from the motor. Not the one in the hardware. Connect the other end to a 12 VDC battery source. The red wire goes to + and the black to -. This will retract the awning. To avoid motor damage disconnect battery source immediately after awning is fully retracted. The awning can be extended by reversing the polarity. Place the red wire on the - and the black wire on the +. Again, remove wires immediately after awning is fully extended.

To Manually Close Awning:

Important: This procedure will require two people. When this procedure has been performed, the awning must be serviced by a Dometic Service Center or a qualified service technician before using again.

1. Slide the pull strap (provided) into the utility slot of the FRTA.
2. While one person is holding onto the pull strap, remove the screw in the top of the right top casting. The FRTA will immediately roll in once the bolt is removed. Walk the awning to the closed position.
3. Align hole where screw was removed and replace screw into top casting to secure awning.

CAUTION

Screw must be re-installed to prevent awning from opening during travel. Have awning serviced by a Dometic Service Center or a qualified service technician before attempting to open awning after this procedure has been performed.

A&E WeatherPro Helpful Hints:

- Whenever the awning is wet while rolled up, as soon as conditions allow, roll it out and let it dry before rolling it up again. This will help prevent the formation of mildew and add greatly to the life of the awning.
- Mildew does not form on the fabric itself, but on the accumulated dust, dirt and grime. Periodically clean vinyl or woven acrylic fabric using a mixture of 1/4 cup of dish soap and 1/4 cup of bleach mixed with 5 gallons of warm water. Liberally slosh the mixture on the top of the fabric and roll the awning up for 5 minutes. This will apply the mixture to the bottom as well. Roll it back out and hose off with fresh water. Repeat if necessary. Allow to dry before rolling up.
- Always make sure the awning is fully extended before opening the entry door.

When To Get More Help:

This User's Guide is intended to provide practical instruction for the sequential operation of the A&E WeatherPro Patio Awning. If malfunctions occur that cannot be corrected by reviewing this Guide, contact a Dometic Service Center or a qualified service technician for assistance.